

ALU VITRUM

Katalog

Prodajni i uslužni asortiman
Catalog of products and services

O nama:

S Vama smo od 2011.god. na adresi Brezovec Zelinski 5b, Donja Zelina, te u izdvojenom proizvodnom pogonu na adresi Kladare 19a, Pitomača. Osnovani smo prvenstveno zbog plastifikacije metala. Zbog učestale potrebe kupaca za plastifikacijom aluminijskih klupica i opšavnih limova proširili smo našu ponudu:

About us:

We have been with you since 2011. on the adress Brezovec Zelinski 5b, Donja Zelina, and in to a separate production facility at address Kladare 19a, Pitomača. Established we are primarily due to powder coating of metal. Due to the frequent need of customers for by powder coating of aluminum windows sills and sheets metal we have expanded our offer:



EUROPSKI STRUKTURNI
I INVESTICIJSKI FONDOVI



Europska unija
"Zajedno do fondova EU"

Tisak kataloga sufinanciran je sredstvima Europske unije iz Europskog fonda za regionalni razvoj.

Sadržaj kataloga isključiva je odgovornost tvrtke
ALU VITRUM d.o.o., Brezovec zelinski 5 b, 10380 Sveti Ivan Zelina
www.aluvitrum.hr

Za više informacija o EU fondovima posjetite stranicu
www.strukturnifondovi.hr

ALU VITRUM

Djelatnosti s kojima se bavimo:

- Plastifikacija metala
- Izrada i plastifikacija aluminijskih klupica i opšavnih limova
- Prodaja aluminijskih limova
- Prodaja aluminijskih trgovačkih profila
- Prodaja aluminijskih profila za ventiliranu fasadu
- Izrada aluminijskih nosača (sidra) za ventiliranu fasadu
- Prodaja aluminijskih kompozitnih panela
- Prodaja zaštitne ljepljive trake za profile i lim
- Prodaja istegnutih metala i perforiranih limova
- Prodaja aluminijskih giljotina sistema
- Prodaja aluminijskih bioklimatskih pergola
- Prodaja aluminijskih profila za solarne panele
- Mogućnost izrade aluminijskih profila po želji kupca

Activities we deal with:

- Metal powder coating
- Production and powder coating aluminium windows sills and surrounding sheets
- Sale of aluminium sheets
- Sale of aluminium standard profiles
- Sale of aluminium profiles for ventilated facades
- Production and sale of anchor production for the ventilated facades
- Sale of aluminium composite panels
- Sale of protective adhesive tapes for profiles and sheets
- Sale of expanded metals and perforated sheets
- Sale of aluminium guillotine systems
- Sale aluminium bioclimatic pergolas
- Sale aluminium profile for solar panels
- The possibility of producing aluminum profiles according to the customer's wishes (custom made, tailor made, bespoke solutions)

Plastifikacija metala

INDUSTRIJSKA PLASTIFIKACIJA SE ODVIJA U HALI POVRŠINE 2200m²

Plastifikaciju vršimo u svim bojama i nijansama, koristeći materijale i sirovine najpoznatijih proizvođača boja za plastifikaciju metala, od kojih posjedujemo i sve važeće certifikate. Prije same plastifikacije vrši se predobrada metala u posebno kontroliranim kadama. Jedan smo od prvih i rijetkih pogona za plastifikaciju koji raspolaže sa pročistačem otpadnih voda, čime ističemo visoki stupanj svjesnosti zaštite okoliša. Kapacitet pogona je 7000 kg za 8 sati rada.



Proizvodni program
Production program





Powder coating of metal

INDUSTRIAL POWDER COATING IS GOING ON IN HALL AREA 2200m²

Powder coating we do using most famous and top quality materials and powders, which have all needed certificates.

Before the actual powder coating is done we made metals pretreatment in strictly controlled baths.

We are one of the first and few powder coating plant which has a waste water treatment, which we emphasize high degree of protection awareness environment.

The factory capacity is 7000 kg / per shift (8 hours).



Najveća dimenzija metala koje možemo plastificirati:

Duljine 7200 mm
Širine 800 mm
Visine 2500 mm

The largest size of metal what we can coating:

Lenght 7200 mm
Widths 800 mm
Heights 2500 mm



Zbog iznimne kakvoće predobrade i plastifikacije ponosni smo vlasnici sljedećih certifikata ISO 9001: 2015, 14001: 2015, OHSAS 18001: 2015 te najprestižnijeg certifikata u našoj branši -QUALICOAT SEA SIDE.



Due to the exceptional quality of pretreatment and powder coating, we are proud owners of the following certificates: ISO 9001:2015, 14001:2015, OHSAS 18001:2015 and the most prestigious certificate in our industry QUALICOAT SEASIDE.



Izrada klupica, čepova, alumijskih opšavnih limova i CNC obrada alumijskih limova i alumijskih kompozitnih panela

Maksimalna dužina alumijske klupice i opšavnog lima koje možemo saviti u jednom komadu je 4000mm. Nakon izrade, alumijske klupice i opšavni limove idu na kemijsku predobradu i nakon toga na plastifikaciju u ral po želji kupca.

Production of aluminium windows sills, accessories for windows sills, aluminium sheets and aluminium composite panels CNC processing.

The maximum length of aluminium windows sills and skirting sheets that we can bend in one piece is 4000mm. After making, aluminium windows sills and sheet metal cladding go on chemical pretreatment and after that on powder coating in Ral according to the customer's wishes.

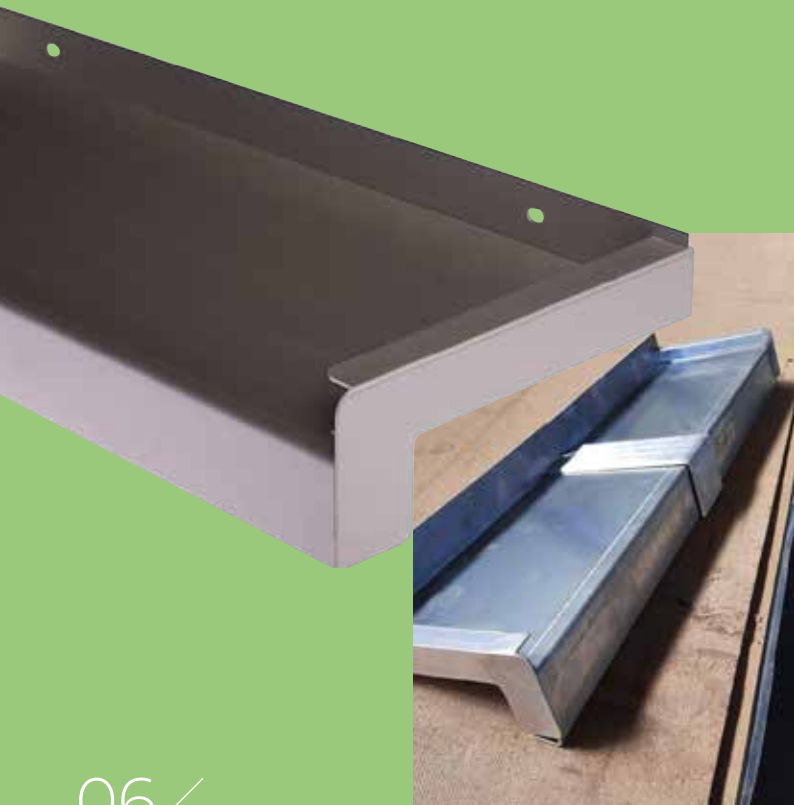

Proizvodnja aluminijskih nosača ventilirane fasade (sidra, ankeri)

PRILIKOM KUPNJE ALUMINIJSKIH NOSAČA IZDAJEMO POTREBNU ATESTNU DOKUMENTACIJU.

Production of aluminium supports ventilated facade (anchors)

AFTER BUYING OUR ALUMINIUM SUBCONSTRUCTION FOR VENTILATED SYSTEMS WE ARE SUPPORTING YOU WITH STATIC CALCULATIONS AND CERTIFICATES FOR MATERIALS.

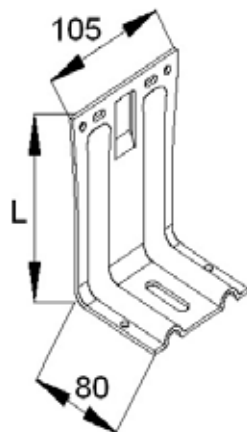

Minimalna
dužina
aluminijskih
nosača

50 mm

Minimum
length of
aluminium
anchor

Maksimalna
dužina
aluminijskih
nosača koju
možemo
proizvesti

400 mm

The maximum
length of
aluminium
anchor what
we can
produce

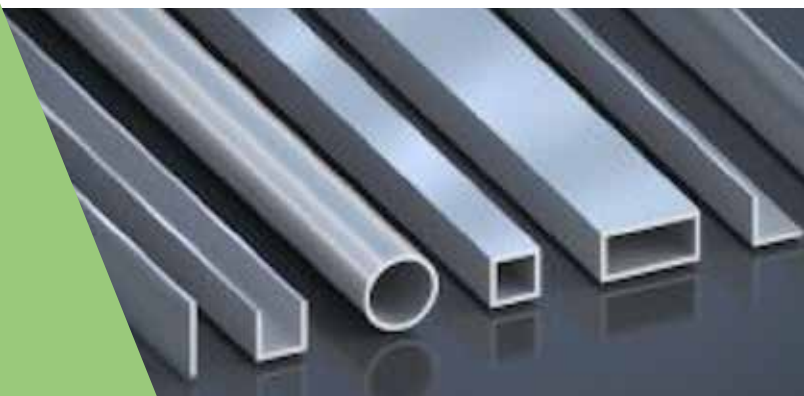

Prodajni program

Sales program



Prodaja aluminijskih trgovačkih profila

Na našem skladištu imamo veliku količinu aluminijskih trgovačkih profila (cijevi, L, U, H,...) različitih dimenzija. Ako nemamo neku određenu dimenziju, u mogućnosti smo u kratkom roku nabaviti i isporučiti traženi profil. Također u vrlo kratkom roku isporučujemo plastificirane

profile u boji po potrebi kupca i time smanjujemo kupcu vrijeme završetka radova. Jedan dio kupaca koristi trgovačke profile za proizvodnju aluminijskih ograda te također i za tu primjenu imamo sve potrebne aluminijske profile na stanju u skladištu.

Sale of aluminum standard profiles

We have a large quantity in our warehouse Aluminium standard profiles (pipe, L, U, H,...) of different dimensions. If we do not have a certain dimension on stock, we are able to purchase in a short period of time and deliver the required profile. Also we are able make powder coating ,for ordered profiles and sheets,according to

the customer's needs, in a short time period. Thus we reduce the customer's completion time of works. A part of customers use standard ones profiles for the production of aluminum fences and also for that application we have everything what is necessary aluminum profiles on stock in our warehouse.

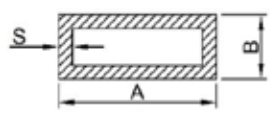

| A | B | S | gr/m | Каталожен номер |
|-----|-----|-----|------|-----------------|
| mm | mm | mm | | |
| 20 | 30 | 1 | 260 | K 230 |
| 20 | 40 | 1 | 314 | K 240 |
| 20 | 40 | 1.2 | 373 | K 240/1.2 |
| 20 | 40 | 1.6 | 492 | K 240/1.6 |
| 20 | 40 | 1.9 | 579 | K 240/1.9 |
| 20 | 60 | 1 | 422 | K 260 |
| 20 | 60 | 1.3 | 545 | K 260/1.3 |
| 20 | 80 | 1 | 530 | K 280/1 |
| 20 | 80 | 1.1 | 584 | K 280/1.1 |
| 20 | 80 | 1.3 | 686 | K 280/1.3 |
| 20 | 80 | 1.5 | 786 | K 280/1.5 |
| 20 | 100 | 1.1 | 638 | K 210 |
| 20 | 100 | 1.3 | 827 | K 210/1.3 |
| 30 | 30 | 1 | 314 | K 330 |
| 30 | 30 | 1.5 | 463 | K 330/1.5 |
| 30 | 30 | 1.9 | 579 | K 330/1.9 |
| 40 | 40 | 1 | 422 | K 440 |
| 40 | 40 | 1.5 | 624 | K 440/1.5 |
| 40 | 40 | 1.6 | 666 | K 440/1.6 |
| 40 | 40 | 1.9 | 785 | K 440/1.9 |
| 40 | 60 | 1.2 | 635 | K 460/1.2 |
| 40 | 60 | 1.7 | 890 | K 460/1.7 |
| 40 | 60 | 1.9 | 991 | K 460/1.9 |
| 40 | 80 | 1.1 | 702 | K 480 |
| 40 | 80 | 1.3 | 827 | K 480/1.3 |
| 40 | 80 | 1.7 | 1074 | K 480/1.7 |
| 50 | 50 | 1.3 | 686 | K 550/1.3 |
| 50 | 100 | 1.8 | 1428 | K 5100/1.8 |
| 80 | 80 | 1.5 | 1276 | K 880/1.5 |
| 100 | 100 | 1.9 | 2020 | K 1010/1.9 |

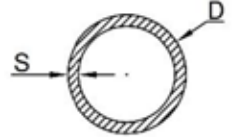

| D | S | gr/m | Profile number |
|----|-----|------|----------------|
| mm | mm | | |
| 19 | 1.2 | 182 | 173006 |
| 32 | 1.5 | 388 | 173004 |
| 40 | 1.5 | 490 | 149007 |
| 50 | 1.5 | 617 | 149015 |
| 60 | 1.5 | 744 | 149014 |
| 80 | 2 | 1323 | 149023 |



| A | B | S | gr/m | Каталожен номер |
|----|-----|-----|------|-----------------|
| mm | mm | mm | | |
| 20 | 20 | 1 | 79 | V 220 |
| 20 | 40 | 1 | 160 | V 240 |
| 20 | 60 | 1 | 214 | V 260 |
| 20 | 100 | 1.2 | 386 | V 210 |
| 30 | 30 | 1 | 160 | V 330 |
| 40 | 40 | 1.2 | 257 | V 440 |

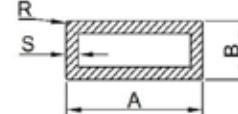

| A | B | S | R | gr/m | Profile number |
|----|----|-----|-----|------|----------------|
| mm | mm | mm | mm | | |
| 18 | 12 | 1.3 | 0.5 | 192 | 149020 |
| 20 | 15 | 1.1 | 1 | 193 | 173003 |
| 20 | 15 | 1.3 | 0.5 | 227 | 149017 |
| 30 | 15 | 1 | 3 | 221 | 149021 |
| 30 | 15 | 1.1 | 1 | 221 | 173002 |
| 30 | 15 | 1.3 | 3 | 284 | 149022 |

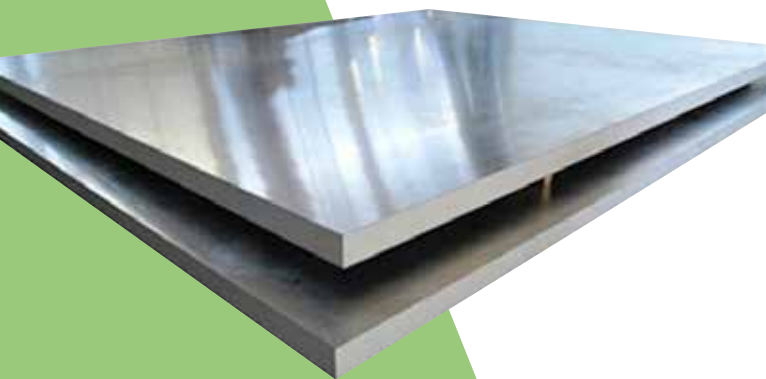

Prodaja aluminijskog lima

Brza nabava i isporuka limova sljedećih legura: EN-AW 3003, EN-AW 3105, EN-AW 5005, EN-AW 5251, EN-AW 5754, različitih debljina i dimenzija.

Sale of aluminum sheet

Fast procurement and delivery of sheets of the following alloys: EN-AW 3003, EN-AW 3105, EN-AW 5005, EN-AW 5251, EN-AW 5754, of different thicknesses and dimensions.

**UVIJEK DOSTUPNO NA SKLADIŠTU;
aluminijske lim legure EN-AW 1050
H14/H24 sljedećih formata:**

**Always available in stock; aluminium
alloy sheet EN-AW 1050 H14/H24
of the following formats:**

1,50 x 1000 x 2000 mm
1,50 x 1250 x 2500 mm
1,50 x 1500 x 3000 mm
2,00 x 1000 x 2000 mm
2,00 x 1250 x 2500 mm
2,00 x 1500 x 3000 mm
2,00 x 2000 x 4000 mm
3,00 x 1000 x 2000 mm
3,00 x 1250 x 2500 mm
3,00 x 1500 x 3000 mm



Aluminijski profil za ventiliranu fasadu

**Aluminium profile for
ventilated facadess**

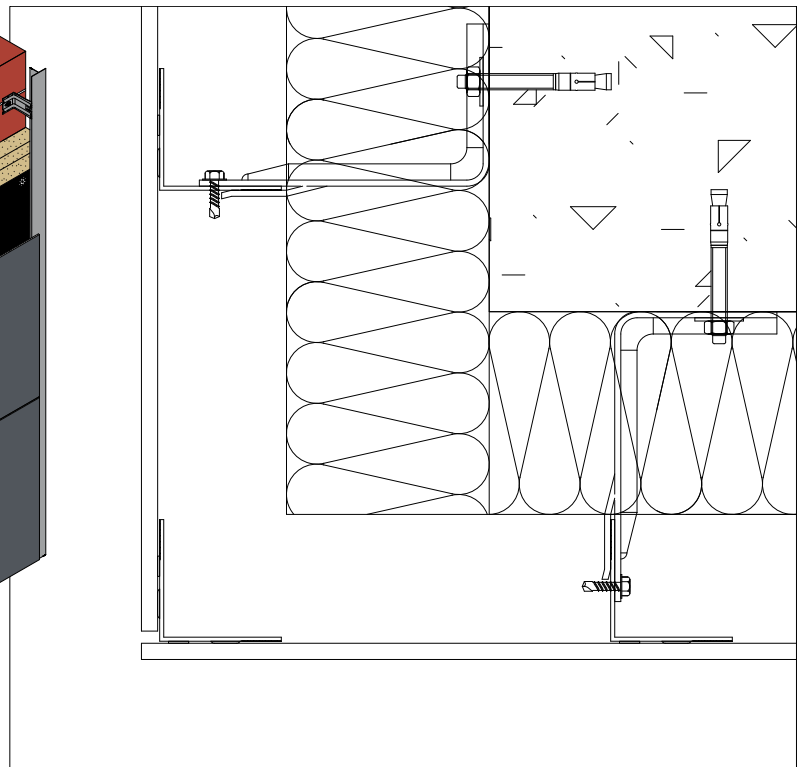
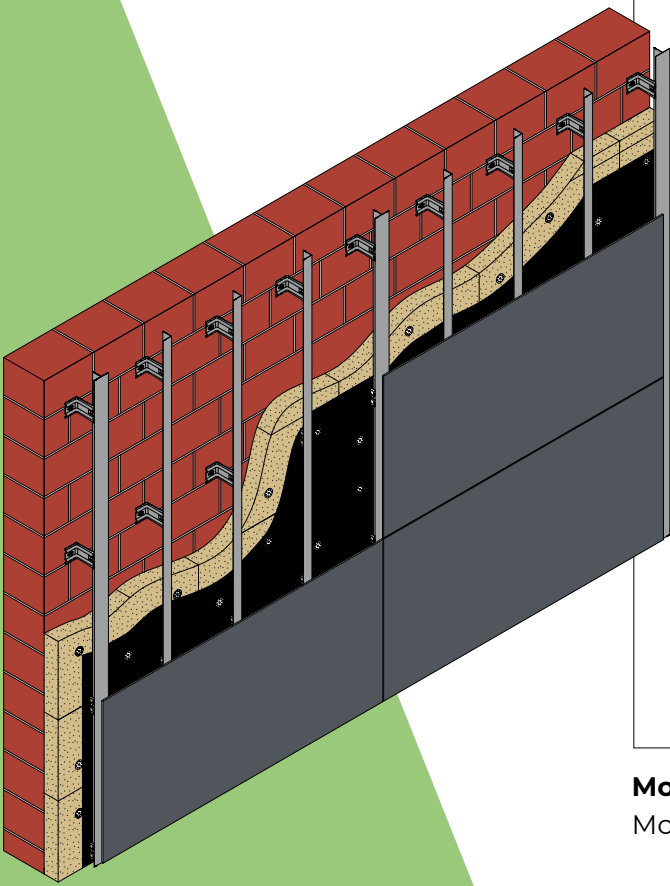

Montaža ljepljenjem
Mounting by gluing

Prodaja aluminijskih profila za ventiliranu fasadu

PRILIKOM KUPNJE PROFILA ZA VENTILIRANU FASADU IZDAJEMO STATIČKI IZRAČUN.

Najčešće se naše podkonstrukcije koriste za sve vrste ventiliranih fasada (aluminijski kompozitni panel, HPL, keramičke, kazetne,...).

Sale of aluminium profile for ventilated facades

WHEN PURCHASING A PROFILE FOR VENTILATED FACADE WE ISSUING A STATIC CALCULATION.

Most often, our substructures are used for all types of ventilated facades (aluminium composite panel, HPL, ceramic, cassette,...).

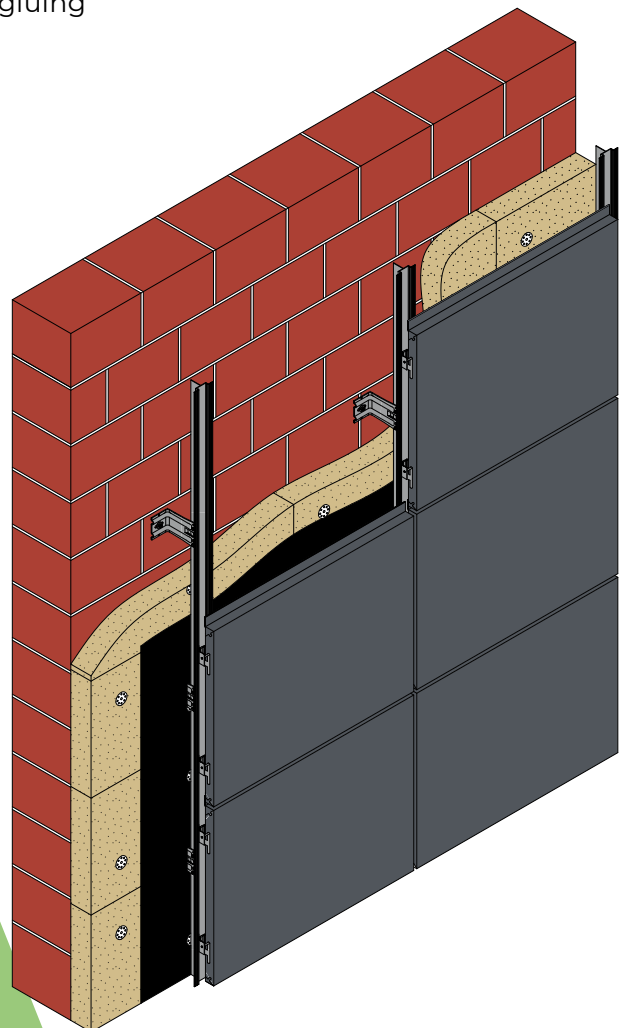

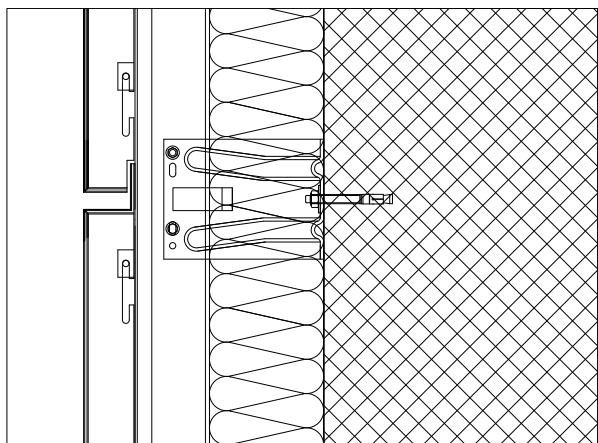

Montaža vješanjem
Mounting by hanging

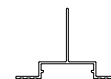
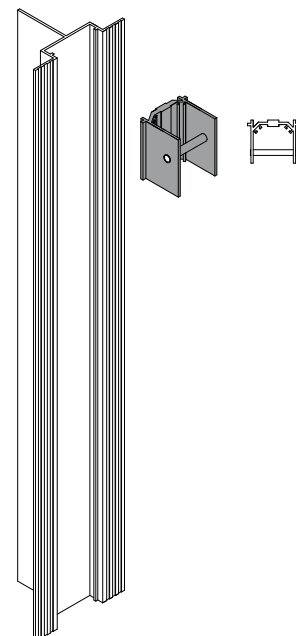
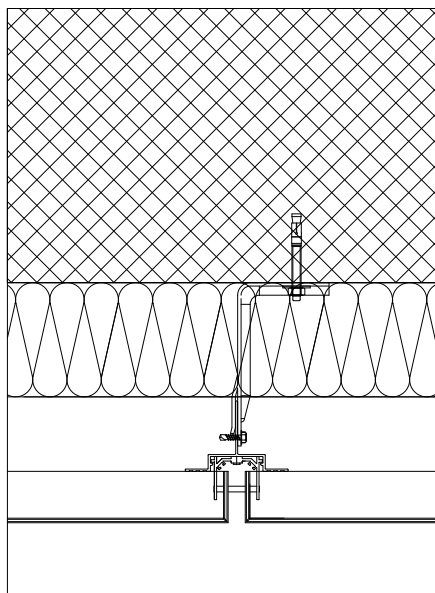

Dužina profila

Profile length

6000 mm

Debljina stjenke

Thickness walls

2 mm

Montaža lijepljenjem

i vješanjem

Assembly
gluing and hanging

1.

Vertikalni aluminijски profil

Za kazetiranu fasadu od aluminijских kompozitnih panela ili lima

Vertical aluminum profile

For cassette aluminum facades composite panels or sheets metal

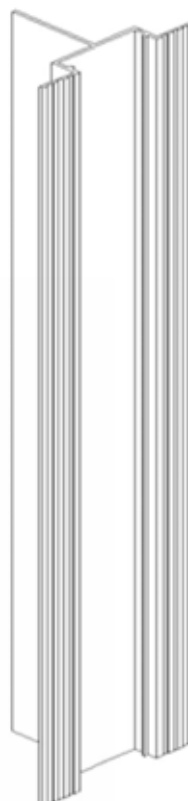

Oznaka profila

Profile-article number

ALP 2289

Debljina aluminijских stjenki profila

Aluminum thickness
profile walls

2 mm

Profili se isporučuju u dužini od

Profiles are supplied
in length of

6 m

W=790 gr/m

1.1.

**Završni
profili za
ventilirane
fasade**

**Closing
profiles for
ventilated
facades**

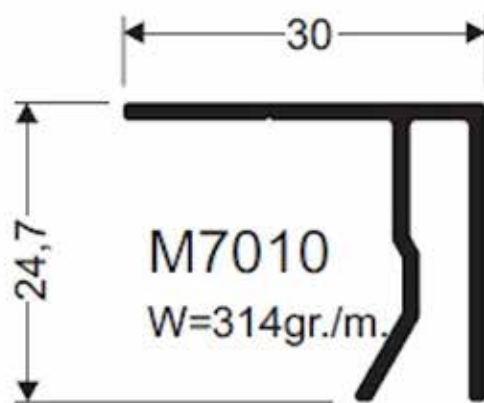

M7010
W=314gr./m.

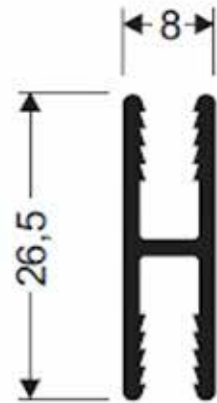

M7013
W=253gr./m.

1.2.

**Aluminijski
L-profil**

60 mm x 60 mm x 2 mm

**Aluminum
L-profile**

Oznaka profila

Profile-article number

ALP 2356 - 363006

**Debljina aluminijskih
stjenki profila**

Aluminum thickness
profile walls

2 mm

**Profili se isporučuju
u dužini od**

Profiles are supplied
in length of

6 m

W=622 gr/m

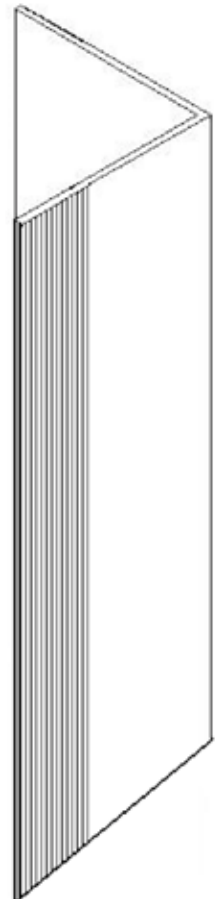
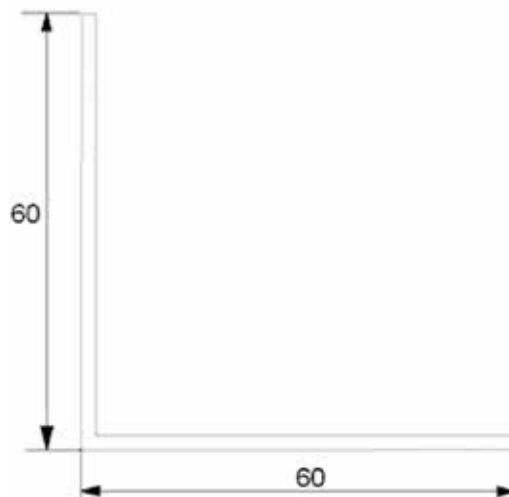

1.3.

Aluminijski L-profil

60 mm x 40 mm x 2 mm

Aluminium L-profile

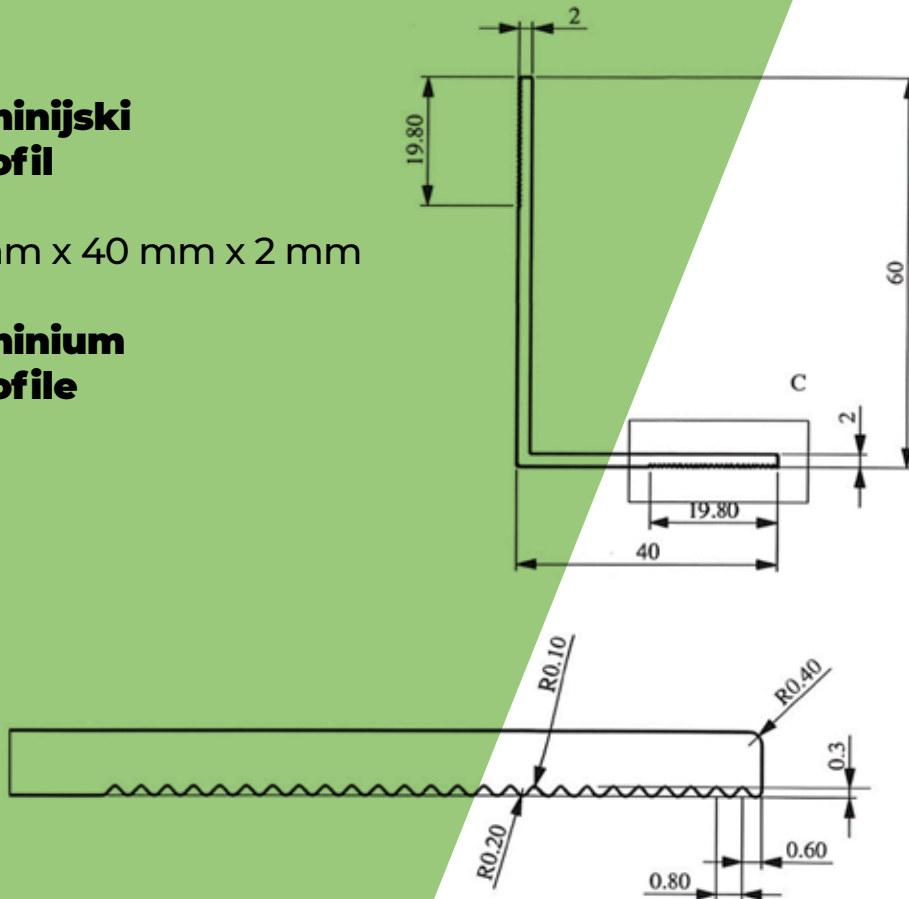

Oznaka profila

Profile-article number

K 0704 - 363005

Debljina aluminijskih stjenki profila

Aluminum thickness profile walls

2 mm

Profili se isporučuju u dužini od

Profiles are supplied in length of

6 m

W=515 gr/m

1.4.

Aluminijski T-profil

100 mm x 60 mm x 2 mm

Aluminium T-profile

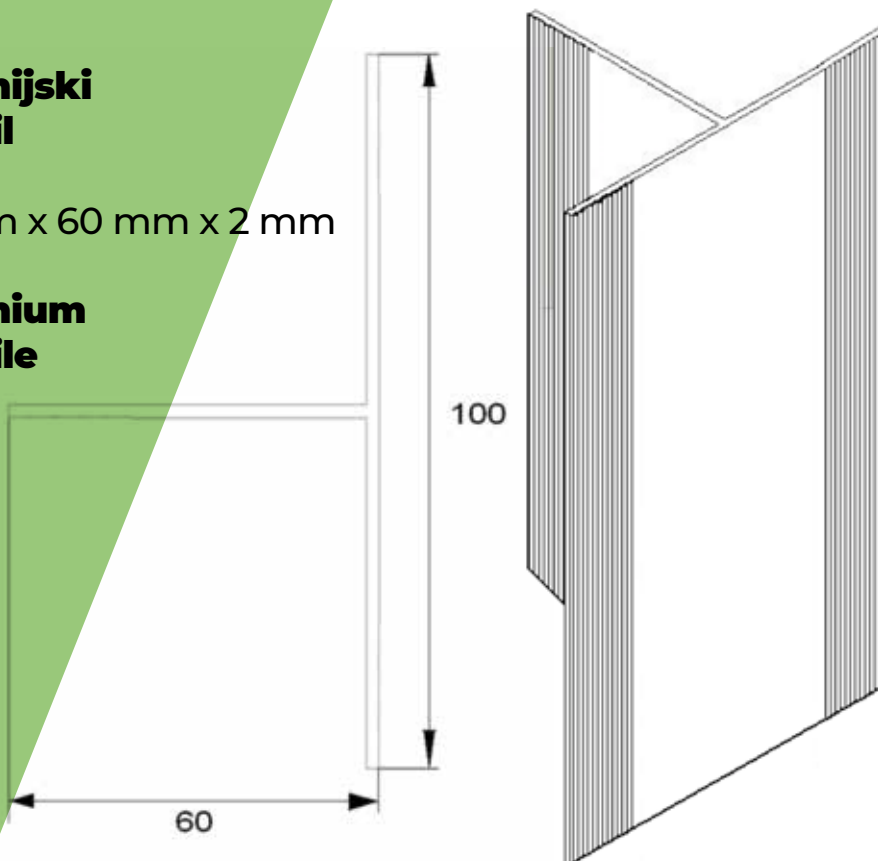

Oznaka profila

Profile-article number

ALP 2357 - 363002

Debljina aluminijskih stjenki profila

Aluminum thickness profile walls

2 mm

Profili se isporučuju u dužini od

Profiles are supplied in length of

6 m

W=826 gr/m

1.5.

Aluminijski T-profil

100 mm x 40 mm x 2 mm

Aluminium T-profile

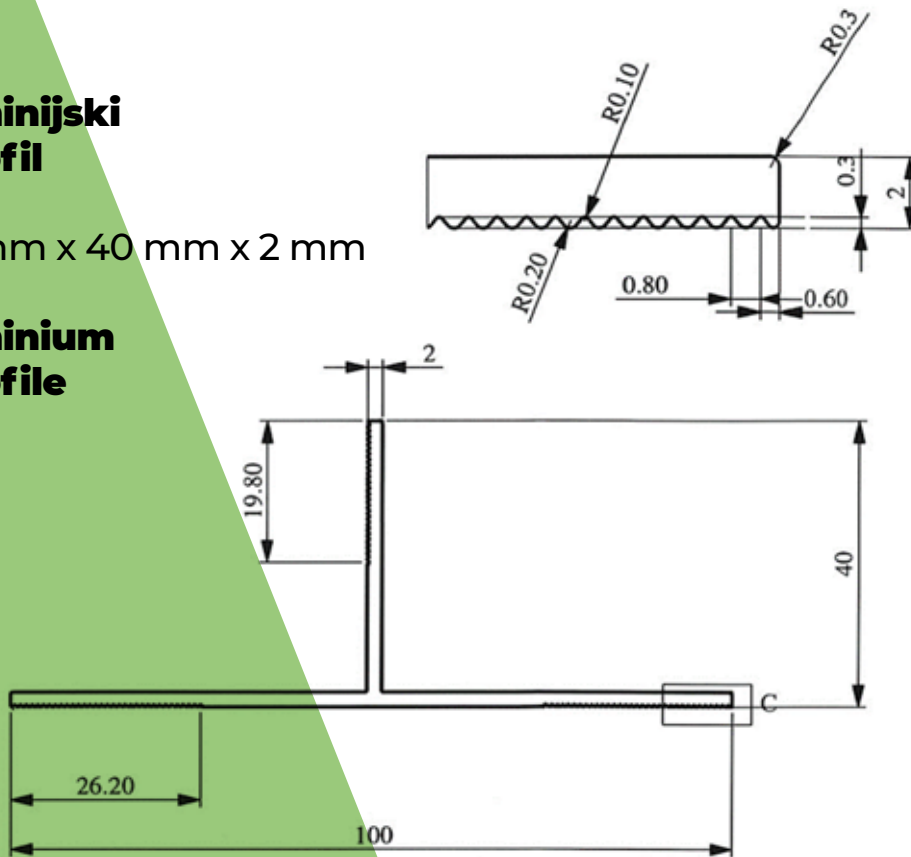

Oznaka profila

Profile-article number

K 0717 – 363001

Debljina aluminijskih stjenki profila

Aluminum thickness profile walls

2 mm

Profili se isporučuju u dužini od

Profiles are supplied in length of

6 m

$W=718$ gr/m

1.6.

Aluminijski T-profil

120 mm x 40 mm x 2 mm

Aluminium T-profile

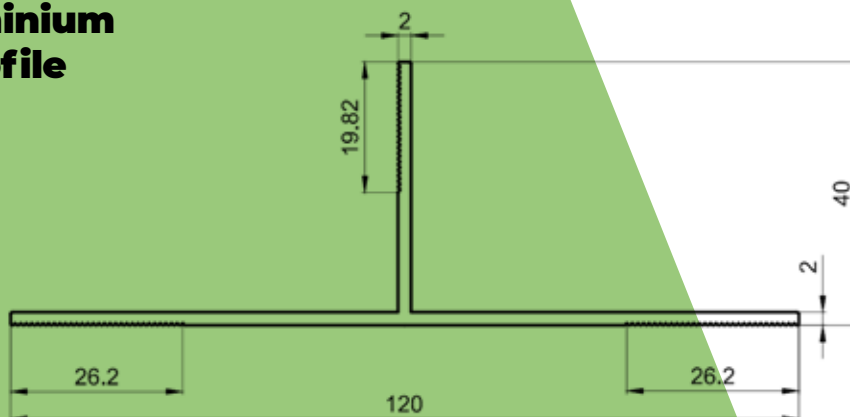

Oznaka profila

Profile-article number

363003-1

Debljina aluminijskih stjenki profila

Aluminum thickness profile walls

2 mm

Profili se isporučuju u dužini od

Profiles are supplied in length of

6 m

$W=826$ gr/m

1.7.

Aluminijski T-profil

120 mm x 60 mm x 2 mm

Aluminium T-profile

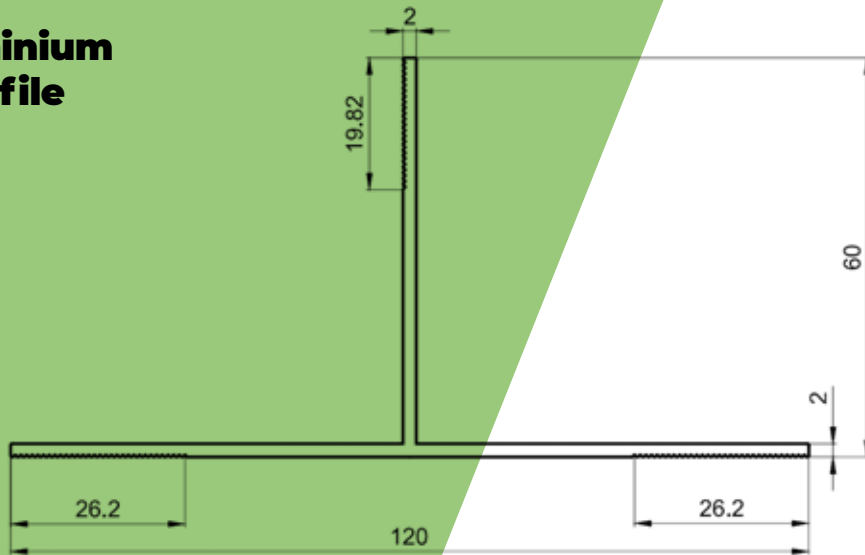

Oznaka profila

Profile-article number

363004-1

Debljina aluminijskih stjenki profila

Aluminum thickness profile walls

2 mm

Profili se isporučuju u dužini od

Profiles are supplied in length of

6 m

$W=934$ gr/m

1.8.

Podložna pločica koja dolazi na aluminijski nosač

A backing plate which comes on aluminum carrier



Pvc podložka koja dolazi ispod aluminijskih nosača - za sprječavanje nastanka hladnog mosta

Pvc washer which comes under aluminium anchor - to prevent formation of cold bridge

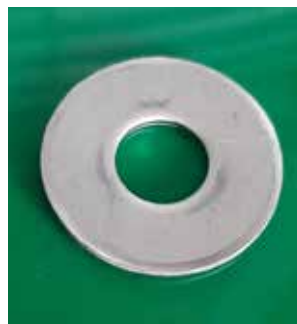

Prodaja aluminijskog kompozitnog panela

Sale of aluminium composite panels

Boje dostupne za aluminijske kompozitne panele definirane su katalogima proizvođača.

Cijena ovisi o odabiru debljine aluminijskog kompozitnog panela kao i o uzorku (drvo dekor, specijalne boje itd..).

Colors available for aluminum composite panels are defined by manufacturer's catalogs

The price depends on the choice of thickness of the aluminum composite panel as well as about the sample (wood decor, special colors, etc..).

Debljina panela / Panel thickness

3 mm 4 mm 5 mm 6 mm

Širina panela / Panel width

1000 mm - 1500 mm

Dužina panela / Panel length

2000 mm - 6000 mm

Kategorija / Category

A2 B1 B2



AB-900 White



AB-901 Pure White



AB 100 Cream



AB-700 Silver



AB 703 Bright Silver



AB-701 Umbra Grey



AB-704 Dark Grey Metallic



AB-702 Anthracite Grey



AB-120 Champagne



AB-130 Bronze



AB-300 Red



AB-301 Burgundy



AB-200 Orange



AB-500 Blue



AB-450 Black



AB-1101 Black Granite



AB-1400 Sparkling Black



AB-1000 Light Walnut



AB-1001 Dark Walnut



AB-1002 Mahogany



AB-1003 Pine



AB-1005 Teak



AB-1006 Thick Golden Oak



AB-1102 Antracite Texture



AB-1104 Corten Steel



SB-900 White



SB-901 Pure White



SB-100 Cream

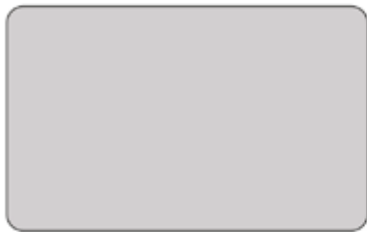

SB-700 Silver

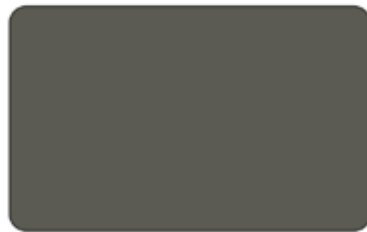

SB-701 Dark Grey



SB-705 Umbra Grey



SB-702 Anthracite Grey



SB-120 Champagne



SB-130 Bronze



SB-110 Gold



SB-140 Copper



SB-300 Red



SB-301 Burgundy



SB-200 Orange



SB-501 Azul Blue



SB-450

Black



SB-500

Blue



SB-1000

Light Walnut



SB-1001

Dark Walnut



SB-1005

Teak



SB-1006

Thick Golden Oak



SB-1007

Textured Teak



SB-1008

Vintage Wood

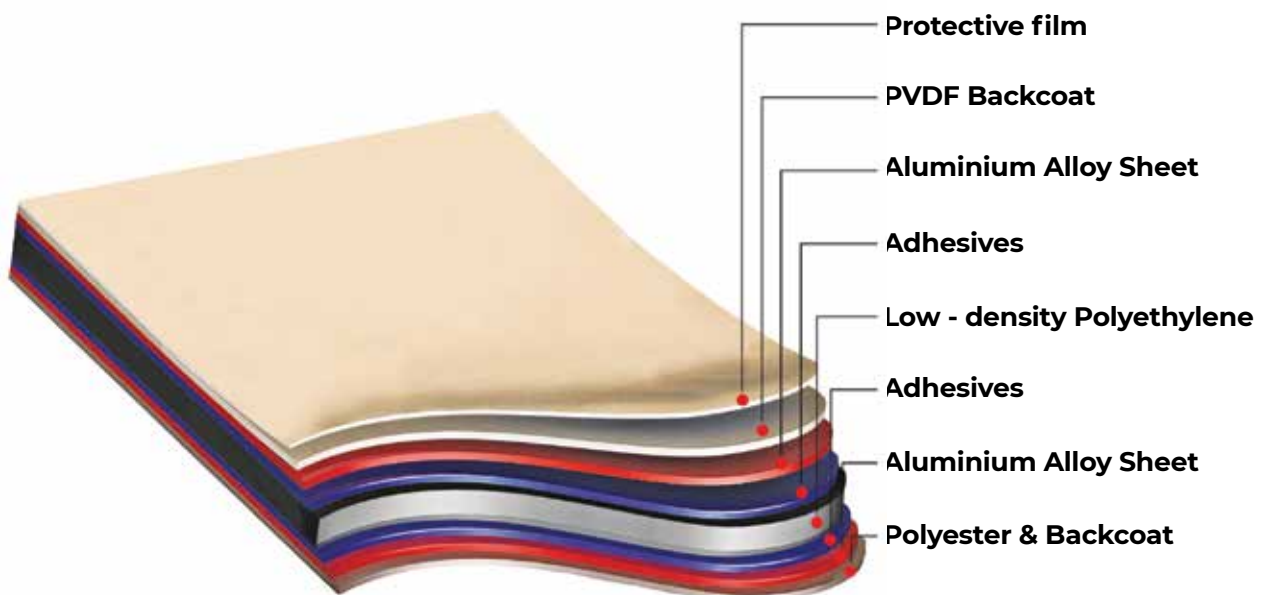



PB-900 White



PB-901 Pure White



PB-100 Cream



PB-700 Silver



PB-701 Dark Grey



PB-702 Anthracite Grey



PB-120 Champagne



PB-130 Bronze

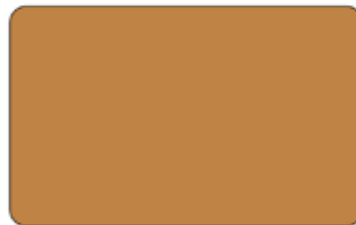

PB-140 Copper



PB-300 Red



PB-301 Burgundy



PB-200 Orange



PB-201 Yellow



PB-800 Brown



PB-600 Green



PB-501 Azul Blue



PB-500 Blue



PB-450 Black



PB-1200 Mirror



PB-1201 Gold Mirror



PB-1300 Satin



PB-1009 Tineo



PB-1010 Wenge



PB-1011 Oakwood



PB-1012 Light Bamboo



PB-1013 Louro Preto



PB-1014 Light Teak



PB-1015 Light Golden Oak

Završni sloj otporan na UV zrake

UV Resistant Film

Dekoratívni sloj

Decorative Layer

Više slojeva Kraft papira

Multiple layers of kraft papers

Dekoratívni sloj

Decorative layer

Završni sloj otporan na UV zrake

UV resistant film

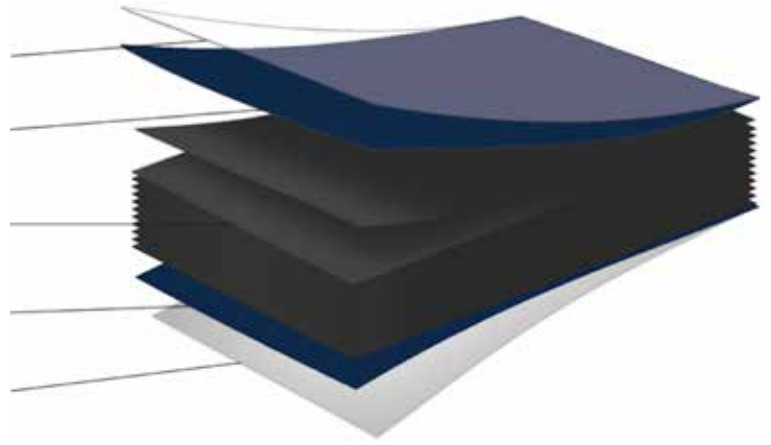
**DUO DESIGNE –**

različiti uzorak s prednje strane i s poledine.

Jezgra HPL može biti u crnoj ili smeđoj boji, osim HPL ploča s oznakom FR čija jezgra može biti samo u smeđoj boji.

DUO DESIGNE –

different pattern on the front and back.

The HPL core can be black or brown, except for HPL panels with marked FR, whose core can only be brown.

Debljina panela / Panel thickness

6 mm 8 mm 10 mm

Standardni format panela / Standard panel format

1300 mm X 3050 mm

Mogućnost narudžbe panela nestandardnih dimenzija / Possibility to order panels non-standard dimensions**Vrsta / Type**

DUO DESIGNE

Isti uzorak s obje strane panela / same pattern on both sides of the panel

Prodaja HPL panela

Sale of HPL panels (high pressure laminate)

HPL // Vanjski // Standardne boje
HPL // Exterior // Solids



Iceberg Rose
1050



White Camellia
1048

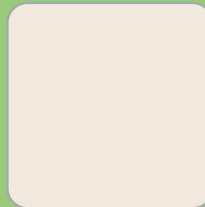

Cream Calla Lily
1039

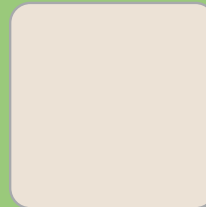

Beige Chalcedony
1016

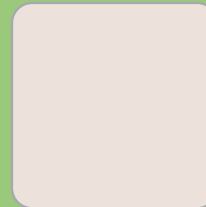

Gray Cineraria
1070



Light Gray Pearl
1081



Gray Moonstone
1036



Moonflower Beige
1012



Silver Brunia
1009

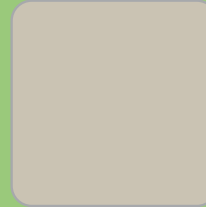

Oyster Gray
1056



Pineapple Pie
1030



Siberian Squill
1087



Almond Butter
1095



Green Jade
1042



Walnut Butter
1096



Orange Begonia
1054



Pink Kunzite
1090

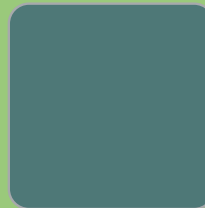

Kale Leaf
1097



Anthracite Gray
1008



Apple Pie
1077



Night Blue
1125



Orange Amber
1075



Gray Pearl
1060



Maple Syrup
1079



Obsidian Gray
1001



Tongass Boulder
1085



Gray Agate
1072

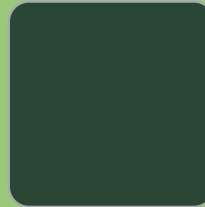

Green Sapphire
1017



Midnight Blue
1068



Chocolate Cosmos
1066

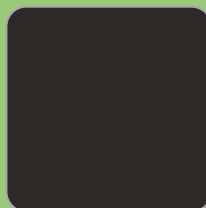

Black Jasper
1049



Bear Creek Chestnut 1
3184



Kinsale Oak 2
3165



Kinsale Oak 1
3164



Portree Oak
3167



Caucasian Walnut
3089



Eire Chestnut 4
3188



Galway Oak 1
3155



Arcata Oak
3175



Killarney Oak 3
3163



Galway Oak 2
3156



Bear Creek Chestnut 2
3185



Borjomi Oak
3186

HPL // Vanjski // Imitacija drveta
HPL // Exterior // Woodgrains

HPL // Vanjski // Imitacija drveta
HPL // Exterior // Woodgrains



Alexandria Teak
3152



Montreal Walnut
3036



Killarney Oak 1
3161



Whistler Oak
3196



Kinsale Oak 4
3168



Kinsale Oak 3
3166



Eire Chestnut 2
3180



Sumatra Teak
3060



Deer Harbor Walnut
3146



Whiteadder Pine
3169



Avoca Beach Stone
5123



Lviv Concrete
5147



Sherbrooke Travertine 1
5128



Leura Granite
5101



Silverton Stone 2
5108



Longmont Stone
5124



Silverton Stone 1
5107

HPL // Vanjski // Imitacija kamen
HPL // Exterior // Stones

Prodaja zaštitne ljepljive trake

MOGUĆNOST ISPORUKE ZAŠTITNE LJEPLJIVE TRAKE RAZLIČITIH ŠIRINA S LOGOM ILI BEZ LOGA

Sale of protective adhesive tapes

POSSIBILITY OF DELIVERY OF PROTECTIVE ADHESIVE TAPES OF DIFFERENT WIDTHS WITH OR WITHOUT A LOGO

Zaštitna ljepljiva traka za normalnu površinu 3C-2

Protective adhesive tape for normal surface 3C-2

1250mm x 500m

1250mm x 460m

Zaštitna ljepljiva traka za hrapavu površinu 3G-9

Protective adhesive tape for rough surface 3G-9

1250mm x 250m



Prodaja istegnutih metala

Sale of expanded metals

Sav istegnuti metal može se proizvesti od čelika, pocinčanog čelika, aluminija, nikla, titanija, bakra ili nekog drugog savitljivog materijala, **debljine 1,5mm, 2mm, 3mm** standardnih dimenzija ili na mjeru po želi i potrebi kupca. Plastifikacija istegnutih metala prema ral karti. Može se ponuditi kao panel isječen na mjeru.

All expanded metal can be produced from steel, galvanized steel, aluminum, nickel, titanium, copper or some other malleable material **1.5mm, 2mm thick, 3 mm** standard size or to measure by wants and needs of the customer. Powder coating expanded metals according to the Ral map. It can be offered as panel cut to size.

Može se ponuditi kao gotov proizvod u okviru napravljenom od U-profila.

It can be offered as a finished product in frame made of U-profile.

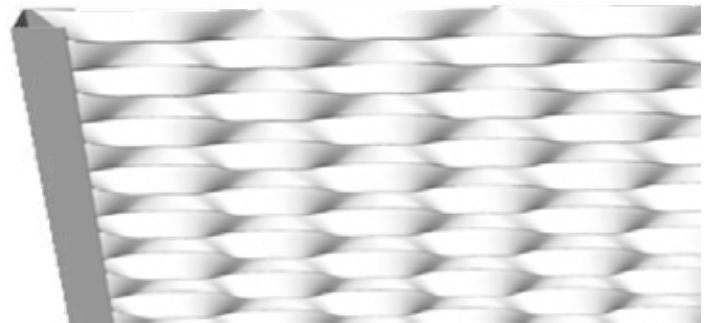

Može se ponuditi kao gotov proizvod u okviru napravljenom od L-profila.

It can be offered as a finished product in frame made of L-profile.



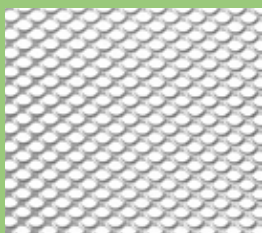

Chelsea

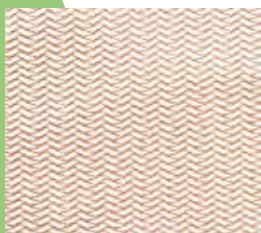

Tribeca

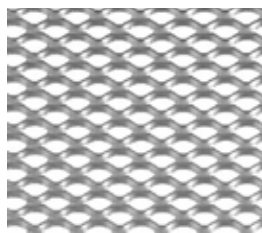

Notre Dame



Soho

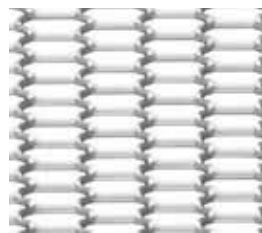

Ribera

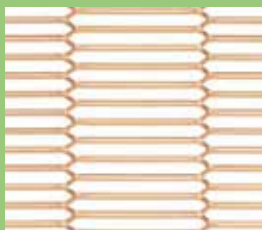

Marais

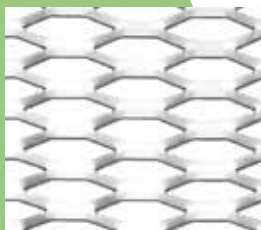

Santa Monica

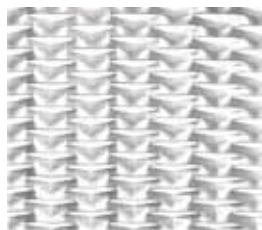

Malibu

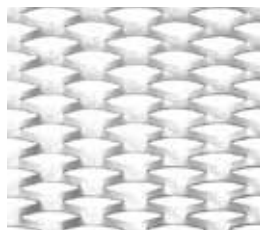

Copacabana

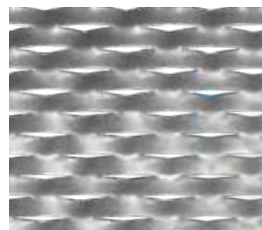

Navigli

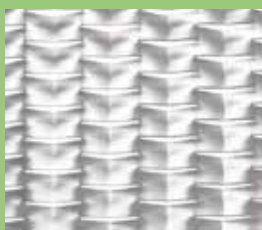

Brooklyn



Brera

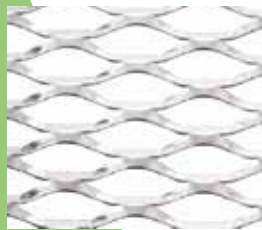

Prater



Opera



Expo



Maracanã



Raval



Picadilly



Flaminio



Pasadena



Hollywood



Big Broadway



Skyline

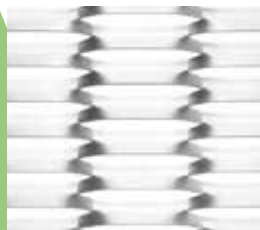

Berg



Manhattan



Broadway

Nabava i prodaja aluminijskih profila za solarne panele

Korištenje aluminijskih ekstruzijskih profila u fotonaponskim (PV) i koncentriranim solarnim (CSP) aplikacijama vrlo je uobičajena i isplativa primjena.

Postotak ovih CSP i PV projekata industrije ekstruzije aluminija koji koriste aluminij u odnosu na čelik ili druge materijale raste iz dana u dan te se time smanjuje opterećenje zgrada s našim aluminijskim profilima koji se široko koriste u infrastrukturi solarnih sustava.

Osim toga, ovi dijelovi otporni na habanje, koji ne zahtijevaju održavanje dugi niz godina, značajno smanjuju investicijske troškove solarnih sustava.

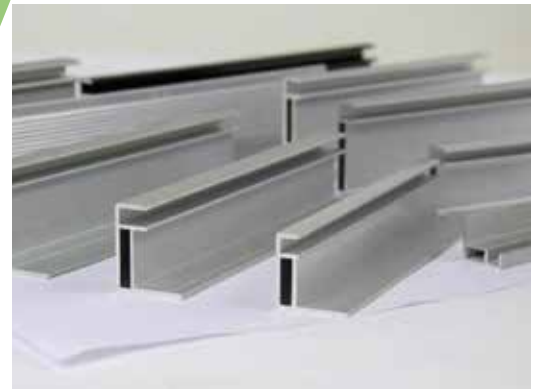

Purchase and sale of aluminum profiles for solar panels

The use of aluminum extrusion profile in photovoltaic (PV) i concentrated solar (CSP) applications is very common and profitable application.

The percentage of these CSP and PV projects the aluminum extrusion industry they use aluminum versus steel or others materials is growing day by day and thus reduces the burden on buildings with our aluminum profiles that are widely used in the infrastructure of solar systems.

In addition, these parts resistant to wear, which do not require maintenance for many years, significantly reduce investment costs of solar systems.



Prodaja aluminijskih "Giljotina" sistema i bioklimatskih pergola

Guillotine stakleni sustav vrlo je koristan sustav s motoriziranim i daljinski upravljanim mehanizmom. Giljotinski stakleni balkonski sustavi također su poznati kao pomični rukohvati. Prostore u kojima se koristi čini širokima i prostranima svojim vertikalnim sustavom kretanja. Mijenja atmosferu stanovanja i radnih mjesta modernom i estetskom slikom koju pruža.

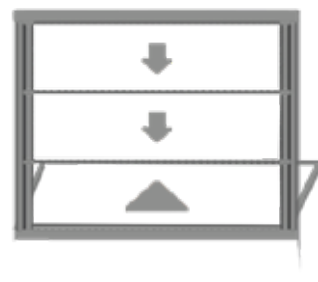
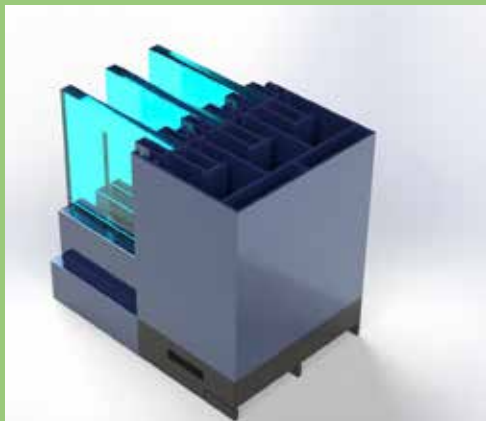

Sale of aluminium "Guillotine" system and bioclimatic pergolas

Guillotine glass system is very useful system with motorized and remote control mechanism. Guillotine glass balcony systems are also known as mobile handle. Spaces where it is used makes wide and spacious with their vertical movement system. It changes the atmosphere housing and workplaces to modern and the aesthetic image it provides.

ALU VITRUM

Naša adresa:

ALU VITRUM D.O.O.
BREZOVEC ZELINSKI 5b
10382 DONJA ZELINA

Proizvodni pogon i skladište:

ALU VITRUM D.O.O.
KLADARE 19a
33405 PITOMAČA

E-MAIL: info@aluvitrum.hr

Web: www.aluvitrum.hr

Kontakti:

+385 91 444 6604

+385 91 444 6615

+385 91 444 6605

poslovođa plastifikacije
prodaja i proizvodnja
računovodstvo

ALU VITRUM

info@aluvitrum.hr
www.aluvitrum.hr